

Mitre-Mite™

VN 4L

Instruction Manual

Version D



TW AMP

Technology for Frame Assembly

888 Forest Edge Drive, Vernon Hills, IL 60061

Phone: 1-800-322-4204

Fax: 1-800-426-7019

Index

1. GENERAL INFORMATION	3		
1.1 PRODUCER	3		
1.2 ASSISTANCE CENTERS	3		
1.3 CERTIFICATION	3		
1.4 WARRANTY	3		
1.5 PRE-ARRANGEMENTS CHARGED TO THE CUSTOMER	3		
1.6 HANDBOOK STRUCTURE	3		
2. MACHINE DESCRIPTION	5		
2.1 WORKING PRINCIPLE	5		
2.2 MAIN COMPONENTS	5		
2.3 MACHINE STRUCTURE	5		
2.4 DIMENSIONS	5		
2.5 SURROUNDING CONDITIONS	5		
2.6 LIGHTING	5		
2.7 VIBRATIONS	5		
2.8 NOISE EMISSIONS	5		
2.9 TECHNICAL DATA	6		
2.10 STANDARD EQUIPMENT	6		
2.11 ELECTROMAGNETIC AMBIENT	6		
3. SAFETY	7		
3.1 GENERAL WARNINGS	7		
3.2 SCHEDULED USE	7		
3.3 INADVISABLE USE	7		
3.4 DANGEROUS AREAS	7		
3.5 PROTECTION DEVICES	7		
3.6 STOP FUNCTIONS	7		
3.7 SAFE WORKING PROCEDURES	7		
3.8 RESIDUAL RISKS	8		
3.9 PLATES	8		
4. INSTALLATION	8		
4.1 SHIPPING AND HANDLING	8		
4.2 STORAGE	8		
4.2 STOCCAGGIO	8		
4.3 PRELIMINARY ARRANGEMENTS	9		
4.4 UNPACKING	9		
4.5 CONNECTIONS	9		
4.6 PRELIMINARY CONTROLS	10		
4.7 MACHINE ARRANGEMENT	10		
4.8 ADJUSTMENTS	11		
4.9 ITEMS TO CHECK BEFORE USING THE MACHINE	14		
5. FUNCTIONING	15		
5.1 OPERATORS	15		
5.2 FUNCTIONING DESCRIPTION	15		
5.3 TIPS FOR PERFECT JUNCTIONS	15		
5.4 MACHINE STOP	16		
5.5 MACHINE REINSTATEMENT	16		
5.6 PUTTING OUT OF SERVICE	16		
6. MAINTENANCE	17		
6.1 STATE OF MAINTENANCE	17		
6.2 MACHINE ISOLATION	17		
6.3 SPECIAL PRECAUTIONS	17		
6.4 CLEANING	17		
6.5 LUBRICATION	17		
6.6 ORDINARY MAINTENANCE	17		
6.7 EXTRAORDINARY MAINTENANCE	18		
		7. DIAGNOSTIC	
		19	
		7.1 SAFETY WARNINGS	19
		7.2 TROUBLESHOOTING	19
		8. SPARE PARTS	21
		8.1 SPARE PARTS LIST	21
		8.2 SPARE PARTS ORDERING	21
		9 DEMOLITION	21
		9.1 DEMOLITION	21
		10. ATTACHMENTS	21
		10.1 DECLARATIONS	21
		10.2 SCHEMES	21

1. GENERAL INFORMATION

1.1 PRODUCER

The firm Alfamacchine - ITW/AMP can boast more than 10 years of experience in the construction of Woodworking Machines. It has acquired technological know-how, developed during years of research in strict touch with manufacturing departments and international commercialization. We offer the best warranty that anyone can grant to its customers.

TEL 800-322-4204

FAX 800-426-7019

1.2 ASSISTANCE CENTERS

ITW/AMP is represented in North & South America by a and prepared sales organization. Contact us directly for the name & number of your closest distributor.

For every need regarding Use, Maintenance or Request of Spare Parts, the Customer should call their distributor.



1.3 CERTIFICATION

The machine is produced in conformity to the pertinent European Community Norms in force at the moment of its introduction on the market.

1.4 WARRANTY

ITW/AMP's products are constructed to have a long life and are tested one by one.

If, in spite of this, if there is any damages or malfunctions, the replacement of defective parts is warranted (counting from the date written on the sales invoice) for a period of:

- 24 months for mechanical components
- 12 months for pneumatic part

The driver blade is tested for about 1.000.000 working cycles. The Warranty does not include the sending of technical staff.

Warranty repairs will be performed at ITW/AMP plants and the freight of shipment will be entirely charged to the Customer.

Warranty does not cover damages caused by an inappropriate use of the machine or not corresponding to the instructions described in this handbook.

The warranty is voided in case of unauthorized modifications or because of accidental damages or tampering performed by unauthorized personnel.

The warranty is also voided if you use v-nails different from the original ITW/AMP ones.

To take advantage of warranty services it is necessary, at the moment you receive your machine, to fill out the warranty card and send it back as soon as possible to ITW/AMP.

The warranty will be valid only after the ITW/AMP receives & records your warranty card.

1.5 PRE-ARRANGEMENTS CHARGED TO THE CUSTOMER

It is the customer's duty, on times agreed with the producer, to execute what is indicated in our documentation.

Things normally charged to the customer:

- Premises predisposition, included building works
- Pneumatic supplyng of compressed air (see the paragraph 4.5)

1.6 HANDBOOK STRUCTURE

The customer must pay extreme attention to the information reported in this handbook, because the proper Pre-Arrangement, Installation and Use of the Machine, constitute the basis of a correct customer-distributor relationship.

1.6.1 Object and contents

The goal of this handbook is to provide to the customer all necessary information so that He would be able to run it in complete autonomy and safety. The handbook contains information concerning the technical aspects, machine working and standby, maintenance, spare parts and safety. Before making any operation on the machine, the qualified technicians and operators must carefully read these instructions. In case of doubt about the correct interpretation of these instructions, ask your distributor to explain it to you.

1.6.2 Utilizers

This handbook is made both for operators and technicians authorized to use or repair the machine.







The operators can not execute operations reserved to the qualified technicians.

The producer does not answer to damages derived from not-observing this prohibition.

1.6.3 Preservation

The instruction handbook must be kept very close to the machine, in a special container protected from liquids and whatever could compromise its legibility

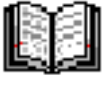
1.6.4 Symbols utilized

 <p>P...</p>	<p>DANGER</p>	<p>It indicates a danger with a mortal risk for the operator</p>
 <p>A...</p>	<p>WARNING</p>	<p>It indicates a warning or a note about key functions or useful information. Pay the maximum attention to the paragraph marked with this symbol.</p>
 <p>O...</p>	<p>OBSERVATION</p>	<p>It is requested to take a measurement data, to check a signal,....</p>
 <p>I...</p>	<p>INQUIRY</p>	<p>The user is requested to check the proper positioning of any element of the machine, before operating a certain command</p>
 <p>C...</p>	<p>EXAMINATION</p>	<p>It's necessary to consult the handbook before performing a certain operation</p>
 <p>R...</p>	<p>ADJUSTMENT</p>	<p>In case of a strange working and/or anomalies, can be requested a certain mechanical adjustment and/or electrical setting</p>

2. MACHINE DESCRIPTION

2.1 WORKING PRINCIPLE

The frame assembling machine Mitre-Mite VN 4L has been realized for the production of medium or large sized frames. The machine is equipped with a V-nail^(R) driver mounted on a movable carriage which can be pneumatically controlled by the operator.

The frame assembling machine Mitre-Mite VN 4L can use special "Power Twist" V-nails^(R) which draw the corners very tight together.

2.2 MAIN COMPONENTS

The main components of the machine are:

- Frontal clamping device to have perfect junctions.
- Adjustable tilting fences.
- Magnetic pressure pads of several types to provide the proper clamping of any profile
- Soft moulding clamp device that adjusts the pressure during the several working phases.
- Dual function foot pedal for separate control of clamping and nail insertion
- Pneumatic opening of the V-nail magazine for very quick reloading
- Nail heads sizes 7, 10 and 15 mm.

2.3 MACHINE STRUCTURE

The direction the machine will move while working is listed below:

- X AXIS
Movement of the horizontal clamp
- Y AXIS
Movement of the vertical clamp

Picture 2. 1 A - Movement directions

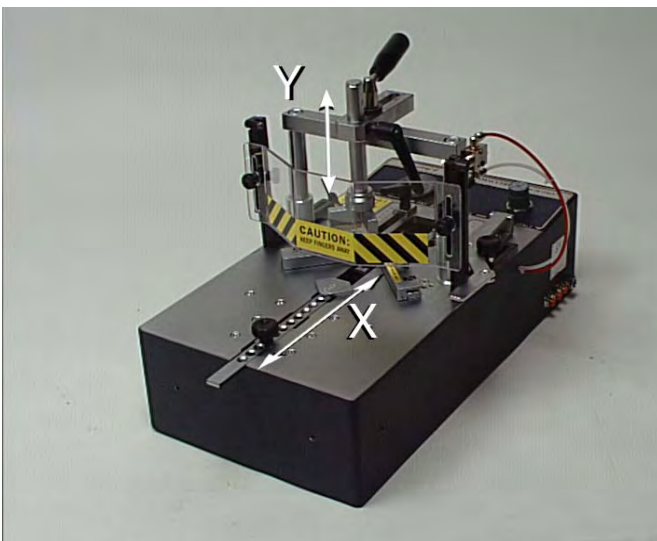

2.4 DIMENSIONS

The overall dimensions are reported on table 2.9-A

2.5 SURROUNDING CONDITIONS

The machine does not need special surrounding conditions. It has to be installed inside an industrial building, lit, aired and with a compact and flat floor. The admitted temperatures go from 41° to 104° F, with an humidity not higher than 50% at 104° F or 90% at 68° F.

2.6 LIGHTING

Premises lighting must be conformed to the norms in force in that Country where the machine is installed. It has to guarantee clear visibility and can't create dangerous light reflections.

2.7 VIBRATIONS

In standard conditions conformed to the indication of machine proper utilization, the vibrations do not create dangerous conditions. The average quadratic weighed level, according to the acceleration frequency to which arms are exposed does not exceed 2,5 m/s².

2.8 NOISE EMISSIONS

The machine is designed and projected for reducing the noise emission level to its source. In standard working conditions the Machine noise power level is:

Acoustic Continuous Equivalent weighed pression A	<70dB
Acoustic Istantaneous weighed pression	<130dB

The noise levels indicated are emission levels and do not represent operating levels. In spite of an existing relationship between emission levels and exposure ones, this can not be used in a reliable way to define if further precautions are necessary. The factors determining the exposure level to which the working force is subjected, include exposure length, working premises characteristics and other noise sources (number of machines, closed area, etc...). Furthermore the allowed exposure levels could change according to several different Countries. At any rate, the information provided, will allow the Machine Operator to achieve a better evaluation of the danger and risks they are submitted to.

	The indicated noise levels are emission ones measured in standard conditions of use. In case of any machine modification, the above mentioned levels could be changed and should be tested on the same machine.
---	---

2.9 TECHNICAL DATA

We have listed below the Machine data and technical characteristics to which you can make reference for any eventual contact with your distributor for Technical Assistance.

TABLE 2.9.A - Technical data

Frames thickness	min.-max. .24" - 4.75"
Frames width	min.-max. .39" - 6.25"
V-nail magazine capacity	n. 220
V-nail size	mm 7-10-15
V-nails size on request	mm 3-5-12
Pneumatic supplying	100 PSI
Weight	about 145 LB
Height of working bench	6.25"
Overall dimensions	13.75" x 25.2" x13.75"

2.10 STANDARD EQUIPMENT

The equipment listed below are the standard parts.

2.10.1 Standard accessories

Once you have removed the packaging, please check the presence of following accessories:).

- N.1 nail head mm. 7
- N.1 nail head mm.10
- N.1 nail head mm.15
- N.1 L shaped pressure pad
- N.1 Rounding pressure pad
- N.1 Allen Wrench 5mm
- N.1 Brass rod magnet

2.10.2 Upgrading and implementing of mechanical parts

The machine has been designed following a modular criterion, therefore the existing equipment can be further upgraded with additional accessories that will not alter its basic structure.

Technical upgrades on the machine model, if any, will be such that they can be installed at any time without requiring any substantial modifications to the machine structure.

2.10.3 Optional accessories

- Floor stand
- Wooden working bench extension
- Metallic working bench extension
- Round and square pressure pads in rubber
- V-nails claw heads size 3-5-12 mm.
- Double mechanical pressure pad
- Triple mechanical pressure pad

2.10.4 Customized optional accessories

Thanks to its versatility this machine can be 'custom-made' to meet our users requirements. With additional accessories, you can make frame assembling easier. ex: special fences for peculiar moulding shapes, special clamps to ensure the mouldings are locked properly during V-nail firing, and so on. These can be special made for you at your local machine shop.

2.11 ELECTROMAGNETIC AMBIENT

The Machine is designed to operate properly in an industrial electromagnetic ambient without altering it being an exclusively pneumatic machine.

3. SAFETY

3.1 GENERAL WARNINGS

The operator must read paying the maximum attention to the information written in this Handbook, expressively about proper precautions for Safety listed in this chapter.

It is advisable for the operator to follow the warnings listed below:

- Keep the machine and the working premises clean & ordered
- Provide appropriate containers to stock the pieces you are going to work with.
- Use the Machine only in normal psycho physical condition
- Wear adequate clothing to avoid obstacles and/or dangerous entanglements to/from the machine
- Wear the individual protection gears described in the instructions handbook
- Do not remove or alter the warning plates and adhesive signs
- Do not remove or elude the Machine Safety Systems
- Keep the fingers away from the working area
- Disconnect the air pressure supply during any maintenance intervention
- Keep the feet separated from the pedal during the Machine maintenance

3.2 SCHEDULED USE

The Machine is designed and built to assemble junctions of frames.

The machine is projected for manual use only (under operator control).

3.3 INADVISABLE USE

The machine can not be used for:

- For uses different from those listed in 3.2 paragraph
- In an explosive or aggressive atmosphere, where there is a high density of dust or oily substances suspended in the air
- In a flammable atmosphere
- Outside in all weather severity
- For working materials not suitable with the machines characteristics

3.4 DANGEROUS AREAS

The area of frames assembly is defined as the “working area”

The dangerous areas of machine, include the movable parts and surrounding zones

Figure 3.4.A- Working area and dangerous zones

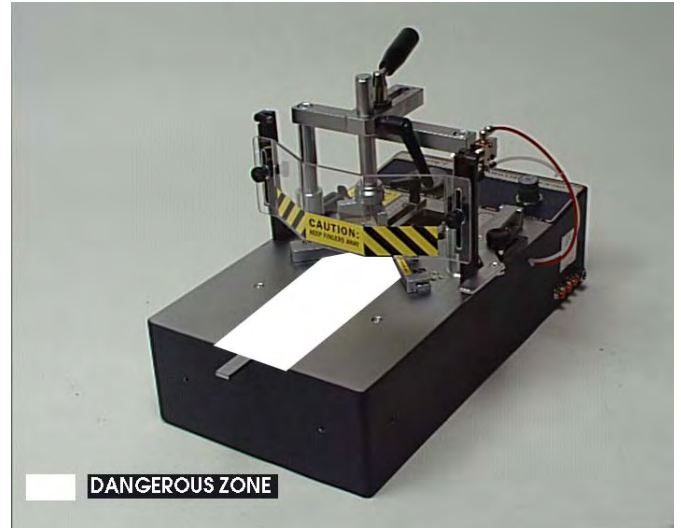

3.5 PROTECTION DEVICES

The machine can be equipped with an optional safety guard.

3.6 STOP FUNCTIONS

The machine stop functions are the following:

- Fast clutch fitting stop (Category 0).
- Foot pedal Stop (Category 1).

STOP CATEGORY 0

It is obtained disconnecting the fast clutch fitting from feed system (uncontrolled stop).

STOP CATEGORY 1

Controlled stop obtained by lifting the foot from the pneumatic pedal that does not allow the v-nails^(R) to drive.

3.7 SAFE WORKING PROCEDURES



The machine is projected and realized to eliminate any risk connected with its use.

The user s requested to achieve an adequate training to be instructed by their local distributor .

The other risks related with using the machine are:

- Finger crushing in the vertical clamp working area
- Finger crushing in the frontal clamp working area

It is necessary to follow carefully the following instructions:

- 1 Keep the fingers away from frontal and vertical clamp working areas
- 2 Disconnect the air pressure during any maintenance interventions
- 3 Keep the foot away from the pedal during machine repairs

3.8 RESIDUAL RISKS

During the normal working cycle and while performing maintenance, the operators are exposed to several residual risks that, because of the operations own nature, can not be totally eliminated.

- Risk of finger crushing in the working areas of the vertical and frontal clamps

3.9 PLATES

The warning plates carrying out safety functions can not be removed, covered or damaged.

To view the plates or adhesive signs location, consult the Fig.10.2-D

Table 3.8 A- Types of plates



Plate concerning the machines characteristics



Adhesive sign concerning the fingers crushing area



Adhesive sign concerning the behaviour to be kept during the working cycle



Adhesive sign concerning the behaviour to be kept during the working cycle

4. INSTALLATION

4.1 SHIPPING AND HANDLING

The shipment must be performed by a professionally qualified staff. The machine has to be shipped in a safe way to avoid any damage to its parts.

- All the protections and guard devices must be properly closed and locked.
- The machine has to be shipped like positioned for installation.
- Before shipping it is necessary to lubricate the parts that are not painted to avoid their detriment.
- According to the type of shipment, it is necessary to protect the machine from any jarring impact or stress

Figure 4.1A – machine handling indications

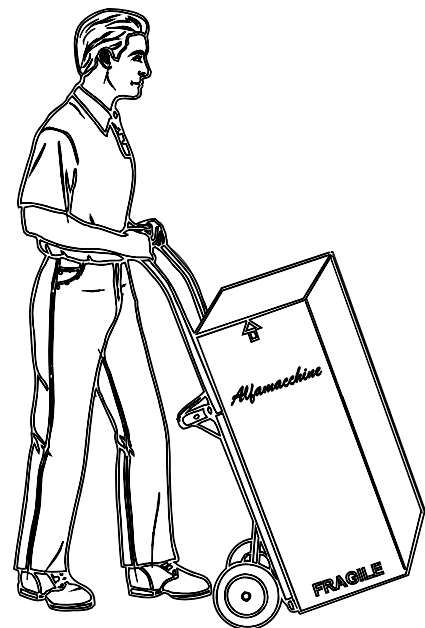

Machine total weight: about 145 LB

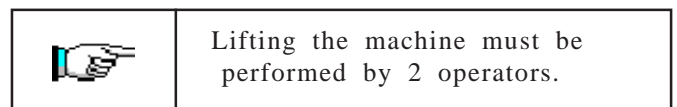

Any damage of the machine caused during its shipment or handling is not covered under warranty.

Repairs or replacements of damaged parts are charged to the customer.

4.2 STORAGE

In case of long inactivity, the machine must be stored with the proper precautions concerning storage place and times.

- Store the machine indoors
- Protect the machine from jarring impacts and stresses
- Protect the machine from humidity and high temperatures
- Store the machine away from corrosive materials
- Lubricate the parts which are not painted

4.3 PRELIMINARY ARRANGEMENTS

In order to install the machine it is necessary to prepare a working area adequate to the machines dimensions. To fulfill the characteristics of precision and steadiness, the bench frame assembling machines must be positioned on a solid and level table able to sustain the weight of the machine.

4.4 UNPACKING

The machine, bench version, is shipped & packed in an appropriate carton and protected by polystyrene parts.

Remove the external packing and save it for a future use.

Check for any casual shipping damage and report it immediately. Shipping damages or any other defects must be reported to **ITW/AMP** within and not later than 3 days from the receipt of the machine.

4.5 CONNECTIONS

To avoid any problems during the setup of the machine, we suggest you follow the instructions listed here below.

4.5.1 Pneumatic connection

The machine uses compressed air and is controlled by a dual action foot pedal.

The 3 pipes for compressed air connected with the pedal must be inserted into the 3 fittings located on machines right side in the following sequence (fig. 2-3):

Upper connection	Red pipe into the red fitting (external side)
Center connection	Black pipe into the black fitting (center fitting)
Lower connection	Transparent pipe into the 3 rd fitting (user side)

Use the supplied fast clutch fitting to connect the machine to the air compressor system. You could use also another fitting suitable with your pneumatic system (see fig. 2).



Picture 1

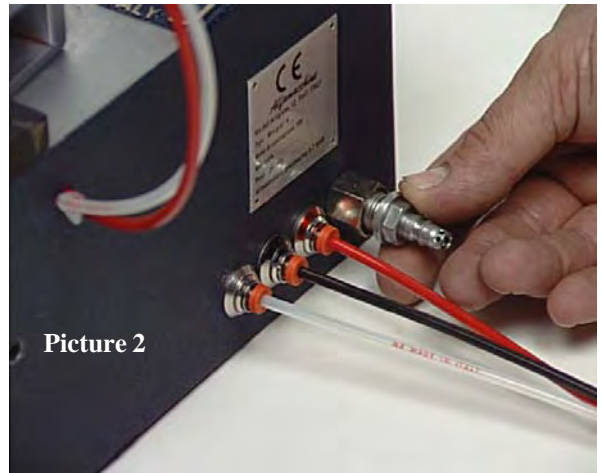

Picture 2

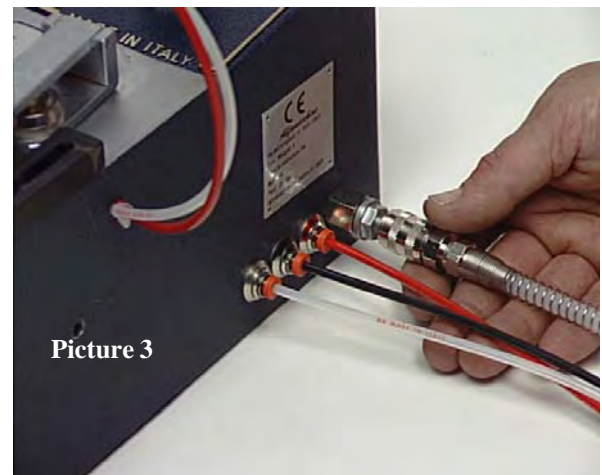

Picture 3



It is advisable to install a filter/lubricator on the air compressed system to provide clean and lubricated air. Use only silicone lubricating oil for pneumatic systems. The use of inadequate oil could damage the valves.

Once you have connected the machine with the pneumatic system, check the proper operation of the foot pedal in the following ways:

- The foot pedal pressed half way down activates the horizontal and vertical clamp
- The foot pedal pressed full down activates the V-nail driver



Check the foot pedal operation when the V-nail magazine is closed. The foot pedal control is deactivated when the V-nail magazine is opened.

4.6 PRELIMINARY CONTROLS

The Machines setup should be performed by a technician appointed from the customer. Before the starting to use the machine , it is necessary to execute certain verifications and checks to prevent mistakes or accidents during setup.

- Verify that the machine has not been damaged during the assembly steps.
- Verify with extreme care, the pipes integrity

4.7 MACHINE ARRANGEMENT

4.7.1 V-Nails magazine loading

To load the V-nail magazine proceed as follows:

- Move the clawpusher backwards by flipping the special lever located on the right side of the machine. This will give you access to the V-nail magazine (see fig. 4).
- Insert one or more V-nails strips into the magazine, taking care that the glue side faces up and that they are loaded with the V of the V-nails pointing in the direction indicated in the figures 5 and 6. Check that the V-nail size is suitable with the type of claw head mounted.
- Move the claw pusher forward by flipping the control lever (see fig.4)

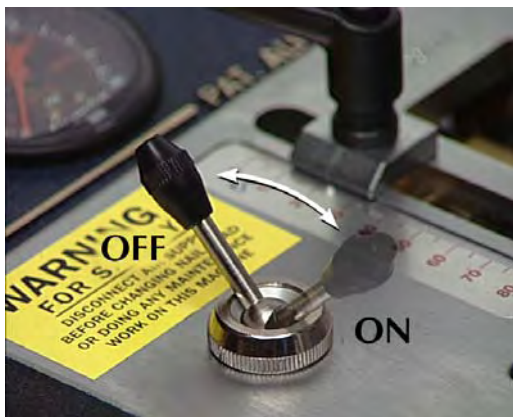

Picture 4

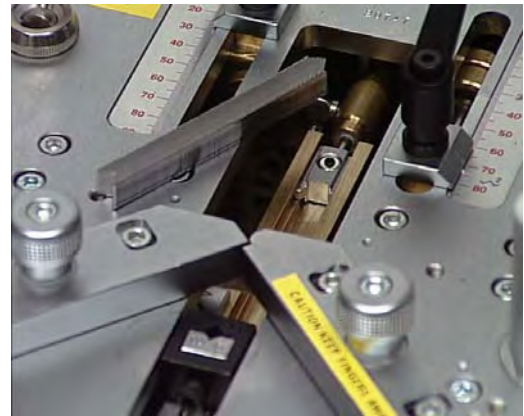

Picture 5

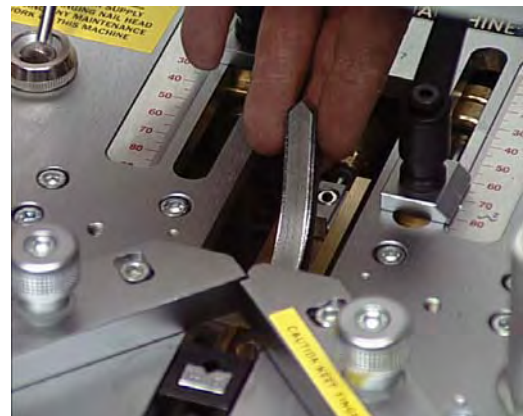

Picture 6

4.7.2 V-nail guide head replacement to change V-nails size

The V-nail guide head must be changed each time you use V-nails of different sizes.

Proceed as follows to replace it:

- Loosen the locking screw of the V-nail guide head using a 5 mm Allen wrench. (The screw is on the opposite side from the V-nails magazine(See fig. 7)
- Remove the V-nail guide head (Claw head)
- Move the claw pusher backwards by flipping the special lever located on the right side of the machine. This will give you access to the V-nail magazine (see fig. 4).
- Remove all the V-nails that are still in the magazine (using the proper brass magnet, if necessary).
- Insert the new V-nail strip(of desired height) into the magazine
- Move the claw pusher forwards by flipping the control lever (see figure 4).
- Insert the new size V-nail guide head to match the V-nails to be used (see fig. 6).
- Tighten the locking screw of the V-nail guide head (see fig.5).

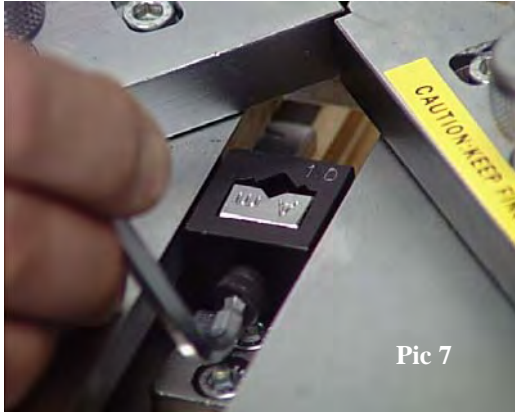

Pic 7

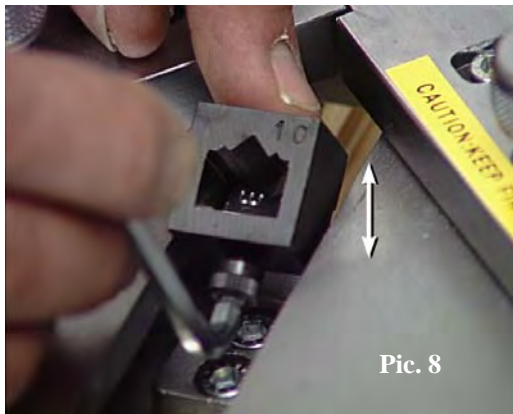

Pic. 8



Pic. 9

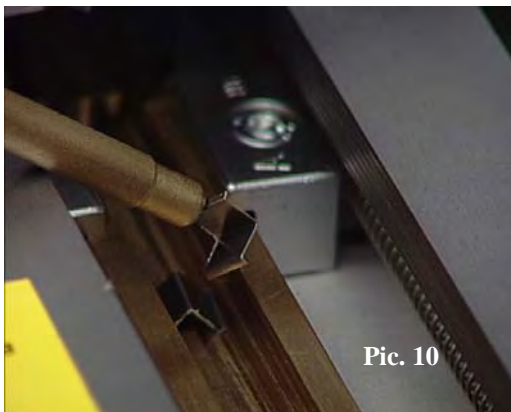

Pic. 10

4.8 ADJUSTMENTS

The machine was completely tested and checked at ITW/AMP before its shipment, the operator has to perform only the following adjustments:

4.8.1 Setting stops for V-nails positioning

The Mitre-Mite VN 4 is equipped with a movable driver assembly that is shifted to the different the V-nail inserting positions.

The limit stops which are located on the machine's working bench, determine the V-nails insertion points.

The positioning of these stops can be changed by means of the handles placed on each stop (fig. 11-12).

The correct measurement of each position is easily set by means of a measurement gauge that refers to the distance between each position and the vertex.

The operator can shift the driver assembly by pressing the special lever located on the right side of the working bench (fig. 13-14).

The Mitre-Mite VN 4 is produced in versions at 2 or 3 positions (respectively 2P and 3P).

The inserting positions are marked as X and Z in the 2P version; X, Y and Z in the 3P one.



TAKE CARE: In the 3P machine it is recommended that you use the X and Z as extreme positions and Y always as the middle one.



ATTENTION: When the machine is not working, the driver assembly is positioned in the X position: to change it, it is necessary to shift the driver assembly to the next positions (Y or Z).

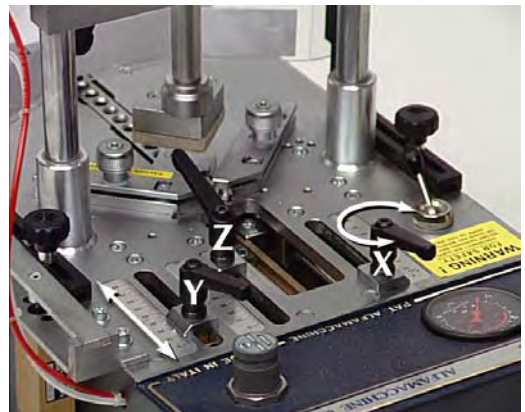

Picture 11

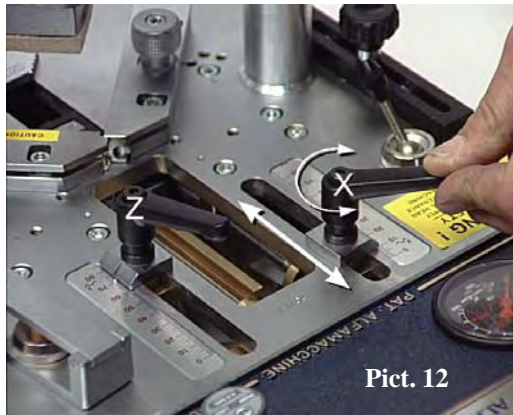

Pict. 12

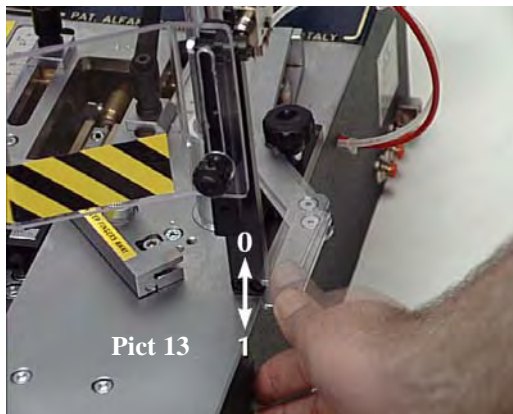

Pict 13



Pict. 14

4.8.2b Vertical clamp height adjustment

- Loosen the handle which is located on the side of the clamp (see fig. 16) and adjust the pressure pad height over the frame until it is between 3/16" - 1/4" above the moulding. This will help prevent any accidental crushing of your fingers.
- Tighten the handle once you have reached the proper position
- Lower the vertical clamp by pressing half way down on the foot pedal to verify that the mouldings to be assembled are properly clamped
- Press all the way down on the foot pedal to insert the V-nail.



Pict. 15

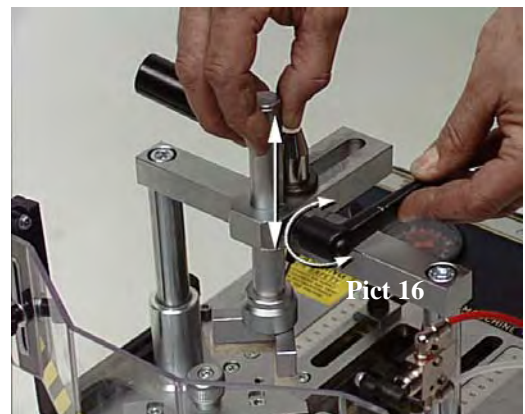

Pict 16

4.8.2 Vertical clamp adjustment

The vertical clamp can be adjusted in height and position.

Proceed as follows to adjust them:

4.8.2a Vertical clamp position adjustment

- Position the mouldings to be assembled on the working bench
- Select the pressure pad suitable with the profile of the moulding to be assembled and put it on the vertical bar
- Loosen the handle (see fig.15), this will allow the clamp to shift forward or backward so it puts the pressure pad directly over with V-nail inserting point.
- Tighten the handle once you have reached the proper position

4.8.3 Frontal clamp adjustment

The Frontal Clamp (horizontal clamp) has a series of holes in the flat bar (see fig.17). Lift the bar upwards to move it forwards and backwards.

To lock the bar it is sufficient to insert it onto the peg located in the middle of the guide channel.

Proceed as follows to position the frontal Clamp correctly:

1. Remove the bar from the peg (lifting it up by about 3/8" - 5/8") and move it forward until it touches the moulding (see fig.18);
2. Lower the bar into the channel & onto the peg.

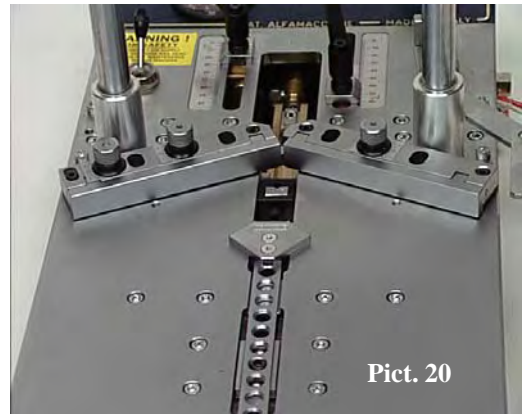
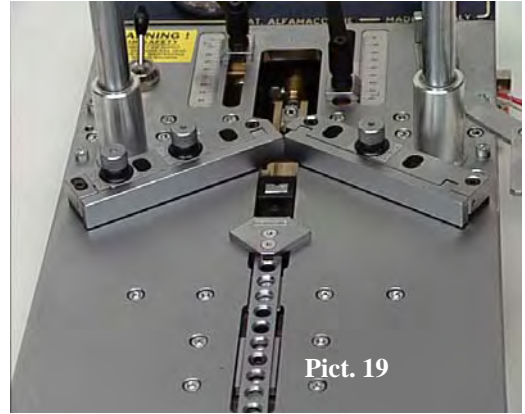
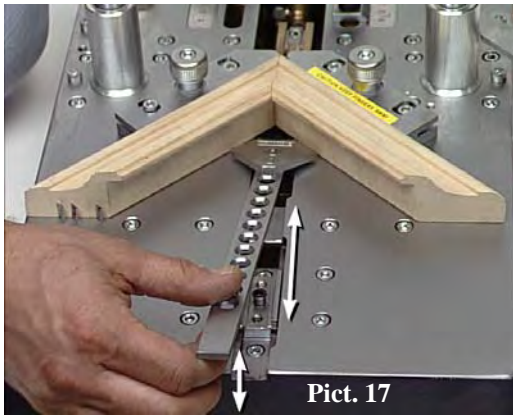

 A5	<p>In case of continued use without needing to remove the frontal clamp from its position, it is possible to fix it to the peg using the proper screw. During machine transport, it is advisable to fix the bar using the supplied knob.</p>
--	--

4.8.4 Fence adjustment

The machine is equipped with a special fence composed of 2 different parts.

Each fence side is equipped with a knob that allows it to tilt the moulding supports.

Furthermore, if the moulding rolls forward or backwards as the front clamps engages, you can adjust the tilting fence to compensate for the defect (fig.18).

In addition to 90 degree frames, the Mitre-Mite VN 4 can also be used for 6-sided (120 degrees) or 8-sided frames (135 degrees), by properly positioning the fence (fig. 19-20).

Proceed as follows to modify the position of fence supports:

- use a 5 mm Allen wrench and remove the outside screw;
- loosen the inside screw slightly and position the fence into the tapped holes located on the working bench.

The proper positioning of the fence can be obtained by using a special square, which is included with your machine. Care must be taken to ensure that the 120° or 135° angle is perfectly centered on the internal vertex of the V-nail head.



4.8.4 Working pressure adjustment

The working pressure must be adjusted to the hardness of the mouldings to be assembled.

The pressure regulation allows you to change the clamping pressure of mouldings to be assembled.

Too high of a working pressure can cause a poor assembly (especially on small-size frames) and the possibility of crushing the moulding.

Too low of a working pressure can cause an incomplete insertion of V-nail into the frame.

The working pressure is adjusted by means of the regulator on the panel near the pressure gauge (see fig. 21).

Proceed as follows to adjust the working pressure:

1. pull up on the regulator cap by about 1/8" to unlock it
2. turn it clockwise to increase the pressure and counter-clockwise to decrease it.
3. push the regulator cap back down, to lock it into position

	<p>DO NOT ADJUST the pressure if the machine is not connected to the compressor.</p>
---	---

The suggested pressures are:

Soft woods	(samba,.....)	30 - 40 PSI
Medium	(ramin,.....)	40 - 60 PSI
Very hard woods	(oak)	60 - 80 PSI

The above listed values apply to 7 and 10 mm high V-nails. Increase the pressure by 10 % for 15 mm high V-nails. When stacking 2 or more V-nails, increase the working pressure by about 10-15 %.

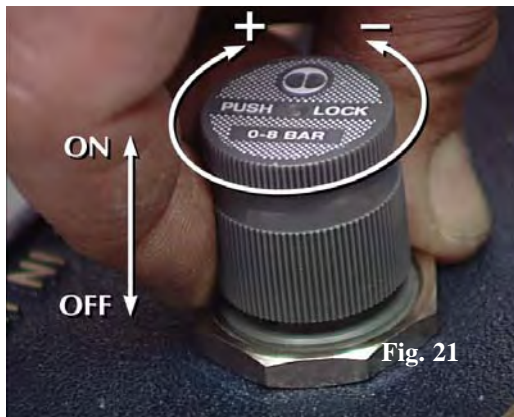

Fig. 21

- The working pressure is adequate to the wood hardness
- The limit stops are properly set (see chapter 4.8.3)
- The protective shield is properly positioned (see chapter 4.8.6)

Proceed as follows to adjust the protection shield:

1. loosen the 2 knobs on both sides of the protection and raise or lower it until it is about 1/4" - 3/8" from the top of the moulding.
2. tighten the knobs to lock the protection shield.

You can purchase the guard as an option for your machine.

Even if the protective shield is properly adjusted, it is necessary to respect the following instructions:

- 3 keep your fingers away from the frontal and vertical clamp working area
- 4 disconnect the pressure supply during any maintenance intervention
- 5 keep the foot separated from the pedal while adjusting the machine

	Opening the guard deactivates the foot pedal
---	--

4.9 Items to check before using the machine

Once the machine has been properly installed check that:

- The magazine is loaded with the type of nails suitable with the moulding to be assembled
- The claw head matches up with the chosen V-nail size
- The limit stops of the driver assembly are positioned in the selected points and properly locked (see chapter 4.8.1)
- The pressure pad is placed on the magnetic support
- The vertical and frontal clamps are properly positioned

	In order to improve the clamping of large moulding sizes or very hard material we recommend you use a multiple clamping device (double/triple mechanic or double hydraulic clamps)
---	--

5. FUNCTIONING

5.1 OPERATORS

The machine has been projected to be used by only one operator.

The staff assigned to operate the machine, must be in possession (or acquire through an adequate training) the requirements indicated below. In addition they must have knowledge of this handbook and of every information concerning safety:

- General and technical culture sufficient to comprehend the handbook contents and understand the drawings and schemes
- Knowledge of main sanitary, technological and anti-accidental norms
- Overall knowledge of the line and plant where the machine is installed
- Specific experience in assembling frames
- To know how to operate the individual protections devices and how to stop the machine in case of an emergency

The Maintenance people, in addition to the above mentioned characteristics, must be in possession of an adequate technical education.

5.2 FUNCTIONING DESCRIPTION

The Mitre-Mite VN 4L is a 3 position machine. This machine has been realized for small and medium size production runs.

The machine has only one possible operating mode:

- Manual functioning using the pneumatic foot pedal and the pneumatic lever which controls the movement of the driver assembly.

Pressing the pneumatic foot pedal half way down causes the clamping of the mouldings.

Pressing the pneumatic foot pedal full down causes it to drive a v-nail.

The control lever permits the movement of V-nail driver assembly

- Pressing the lever half way down causes the driver assembly to move from the 1st to the 2nd inserting position; pressing it all the way down causes it to shift to the 3rd inserting position.

To assemble a corner, operate as follows:

1. Set the insertion position handles (see chapter 4.9.1)
2. Position the moulding to be assembled on the working bench
3. Adjust the vertical clamp height and positioning (see chapter 4.9.2)
4. Adjust the frontal clamp position (see chapter 4.9.3)
5. Check & adjust the clamp pressure according to the hardness of the material to be assembled(see chapter 4.9.5)

6. Press half way down on the foot pedal and verify the proper positioning and clamping of the mouldings
7. Press the foot pedal full down to insert the V-nail (if the mouldings profile needs 2 or more V-nails stacked in the same position, release the foot pedal halfway and then press it again to insert the 2nd V-nail and so on)
8. Release the pedal halfway
9. Press the lateral lever halfway to position the V-nail ejection group in the next inserting point
10. Press the foot pedal full down to insert the V-nail (see step 7)
11. Release the pedal halfway
12. Press the lateral lever all the way down so the driver assembly shifts to the last insertion point
13. Press the foot pedal full down to insert the V-nail (see step 7)
14. Release the foot pedal completely to release the vertical and the frontal clamps.

5.3 TIPS FOR PERFECT JUNCTIONS

a) V-nail types

In order to allow the machine to make excellent quality junctions using different materials, it has been necessary to manufacture different V-nails types for different uses (see attachment D).

V-nails can be classified in three different groups:

for soft woods and soft plastic	Suggested V-nail code	SPT
for medium woods	Suggested V-nail code	HPT
for hard woods	Suggested V-nail code	HPT

b) Assembling positions

It is advisable to operate as follows in order to achieve the best results in terms of junction quality:

Never drive V-nails near the junction vertex. The minimum recommended distance from the external vertex is at least 10 mm.

When you want to make the junction using only one V-nail, the most suitable position is in the middle of the moulding (see fig. 23)

In case you want to insert 2 or more V-nails into each junction, we recommend you to insert the most external one 1/3 from the external vertex and the most internal one 1/4 from the internal vertex.

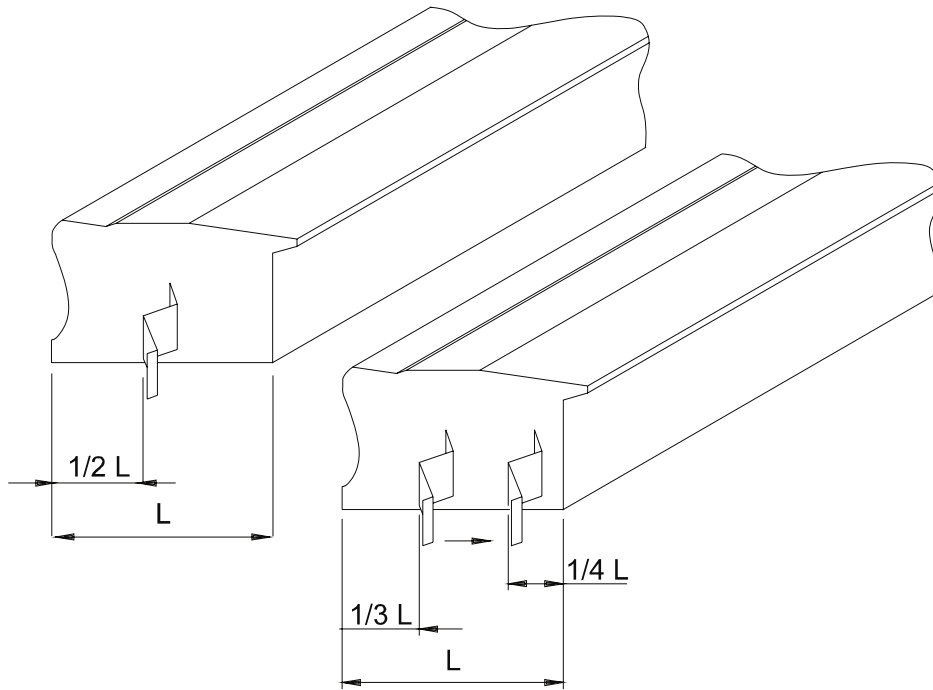

figure 23

5.4 MACHINE STOP

The machine can only work by pressing the pneumatic foot pedal; to stop it is enough to lift the foot from the pedal.

It is also possible to disconnect the fast clutch fitting from the compressed air.

5.5 MACHINE REINSTATEMENT

The machine reinstatement is performed by pressing the pneumatic foot pedal.

5.6 PUTTING OUT OF SERVICE

In case on long inactivity periods it is necessary to disconnect the fast clutch fitting from the pneumatic system.

6. MAINTENANCE

6.1 STATE OF MAINTENANCE

The maintenance operations must be performed with the machine in the conditions described at the “state of the machine” in the tables 6.6.A and 6.7.A

6.2 MACHINE ISOLATION

Before performing any type of maintenance or repair , it is necessary to isolate the machine from the following supplying sources:

- 1) Disconnect the fast clutch fitting from the pneumatic system.

Once you have finished the maintenance intervention & before reconnecting the pneumatic supply, make sure that any & all components and any pneumatic connections are properly reinstalled.

6.3 SPECIAL PRECAUTIONS

During the maintenance or repair operations is suggested to proceed as follows:

- Before starting any operation place a sign “machine under maintenance” in a highly visible position
- Do not use solvents or flammable materials
- Do not step on the machine parts, because they have not been manufactured to sustain the weight of people.
- Once all the operations are finished, reinstall the protections or shields you removed or opened

6.4 CLEANING

The machine structure is simple and robust therefore the mechanical parts do not require any special maintenance.

It is advisable to follow the rules listed below:

- Regularly remove glue or other residues from the V-nail head and from the upper part of the driver blade;
- Always keep the V-nail magazine clean
- Remove any residue from the V-nail guide “L” shaped support.

Do not use water to clean the machine, otherwise the metal parts may rust.

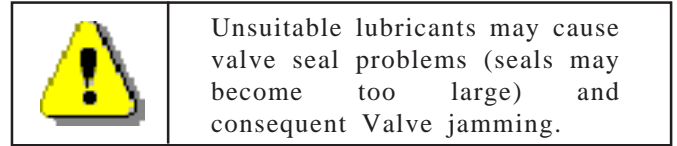

6.6 ORDINARY MAINTENANCE

The following operations must be executed at the times indicated below. Not observing the following instructions exonerate the Producer from any responsibility regarding the warranty. The operations described below, even if simple, must be executed by qualified personnel.

The ordinary scheduled maintenance includes overhauls, checks and interventions that will help prevent stops and breakdowns.

- Lubrication state of the machine
- Wear and tear parts state

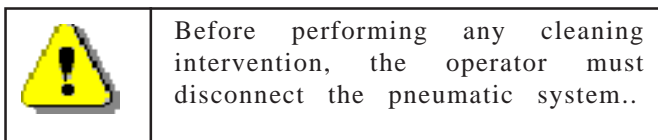

6.5 LUBRICATION

Preferably CASTROL MAGNA GC 32 or equivalent oil

Furthermore, we recommend you lubricate the driver blade every 200 working hours.

Table 6.6.A - Ordinary Maintenance

Maintenance	Description	Machine state
V-nail driver blade	Replacement every 1.000.000 V-nails shot	Isolation for maintenance
Movable parts lubrication	Lubricate the driver blade every 200 working hours	Isolation for maintenance
V-nail claw heads	Replacement every 5.000.000 V-nails shot	Isolation for maintenance
“L” shaped supports (V-nail guide)	Replacement every 5.000.000 V-nails shot	Isolation for maintenance

6.7 EXTRAORDINARY MAINTENANCE

Listed below are the operations that need the intervention of ITW/AMP , your distributors Technical Assistance (see the paragraph 1.2) or by qualified staff authorized by the Producer

The extraordinary maintenance includes interventions to be performed in exceptional cases:

- Breakage
- Revisions

TAB. 6.7 A

MAINTENANCE	DESCRIPTION	MACHINE STATE
Valves and Reducers	Suggested replacement every 6/8 million of V-nails shot	Isolation for maintenance
Frontal and vertical clamp gaskets	Replacement in case of air leaks	Isolation for maintenance

7. DIAGNOSTIC

7.1 SAFETY WARNINGS

The interventions must be performed by personnel properly trained and must take all precautions in order to avoid accidental starts.

7.2 TROUBLESHOOTING

TABLE 7. 2 - A

TROUBLE	POSSIBLE CAUSE	REMEDY
Pressing the foot pedal the V-nail ejection is irregular	Insufficient working pressure	Check that the minimum value indicated from the main regulator is higher than 3 Bar
Pressing the foot pedal the V-nail ejection is irregular	V-nails placed wrong in the magazine	<ul style="list-style-type: none"> - Check that the V-nails glue side faces up - Check that V-nails V vertex is pointing toward machine's external side -Defective nails- replace them
Pressing the foot pedal the V-nail ejection is irregular	Guide channels damaged or jammed	- Check that the guide channels are not dirty or jammed
Pressing the foot pedal the V-nail ejection is irregular	Claw pusher has insufficient thrust	Check that the pressure on the claw pusher cylinder is at least 2 Bar. If necessary, increase it by 10%.
Pressing the foot pedal the V-nail ejection is irregular	Claw head not suitable with V-nails size	Check that the number engraved on the v-nail claw head matches up to the V-nails size
Pressing the foot pedal the V-nail ejection is irregular	Faulty V-nails	<ul style="list-style-type: none"> - Replace the V-nails - Use shorter sticks of V-nails
Pressing the foot pedal the V-nail ejection is irregular	Insufficient working pressure	Check that the air pressure coming out from the compressor is at least 3 Bars.
Pressing the foot pedal the V-nail ejection is irregular	Opened V-nail magazine	Close the magazine by means of the special lever
Pressing the foot pedal the V-nail ejection is irregular	Faulty valves	<ul style="list-style-type: none"> - Replace the foot pedal valve - Replace the control valves
Pressing the foot pedal for several times the machine's working that was correct at the beginning becomes irregular later	Jammed valves because of surplus of oil or condensation	-Remove the surplus of oil and condensation from the valves by disconnecting one by one the control pipes -making the oil/ water come out with the air
Pressing the foot pedal the working pressure indicated on the regulator deeply decreases	Faulty pressure regulator	-Replace the regulator
Pressing the foot pedal the working pressure indicated on the regulator deeply decreases	Feeding pipe too long or of inadequate diameter	Replace the piping with a new one of bigger diameter

TROUBLE	POSSIBLE CAUSE	REMEDY
Pressing the foot pedal the machine works properly, but once the pedal is released you can note a certain delay in re-positioning of driver blade and/or vertical clamp cylinders	Faulty or jammed valves	<ul style="list-style-type: none"> - Remove the surplus of oil and/or condensation - Replace the foot pedal valve - Replace the faulty control valves
Wishing to insert several V-nails one upon the other in the same point, they do not stack properly or tilt during their insertion	Unsuitable V-nails	Replace the V-nails with suitable ones <ul style="list-style-type: none"> - Check and in possibly replace the vertical and frontal clamping positions
Wishing to insert several V-nails one upon the other in the same point, they do not stack properly or tilt during their insertion	Poor frames clamping (the frame moves during the V-nail insertion)	<ul style="list-style-type: none"> - Increase the pressure by using the regulator - Replace the pressure pad with the proper one
Wishing to insert several V-nails one upon the other in the same point, they do not stack properly or tilt during their insertion	Worn driver blade	Replace the driver blade
Wishing to insert several V-nails one upon the other in the same point, they do not stack properly or tilt during their insertion	Jammed driver blade	Clean the driver blades upper part removing any material jamming the upper profile

7.3 REQUEST OF ASSISTANCE

For any information regarding Use, Maintenance, Installation, etc.. we remain at your disposal. The Customer can send a detailed fax describing the problems encountered. For eventual explanations we suggest you use this handbook and the instructions listed in the paragraph 1.2. as a reference.

FAX: 1-800-426-7019
Phone:1-800-322-4204
 Web Site: www.itwamp.com
 E-Mail: itwamp@paslode.com

8. SPARE PARTS

8.1 SPARE PARTS LIST

Even though the machine has been submitted to several tests and functional checks, we have listed below the components that we suggest you to have to guarantee the minimum possible downtime.

TABLE 8.1 - A

COMPONENT
<ul style="list-style-type: none">• V-NAIL DRIVER BLADE• V-NAIL CLAW HEADS• "L"SHAPED SUPPORT (V-NAIL GUIDE)• VALVES-REDUCERS-REGULATORS• VERTICAL AND HORIZONTAL CLAMPING GASKETS

8.2 SPARE PARTS ORDERING

We remind you that only a qualified technician can repair the machine. Thus, we suggest the intervention of ITW/AMP's or your local distributor's Center of Technical Assistance, which is disposable with qualified staff, proper equipment and tools, and with original spare parts.

To order the above listed spare parts, send by fax or letter with the following data:

- Model of the Machine
- Code of exploded parts drawing
- Reference number of spare part or group indicated on the mechanic drawing
- Code number of single or group spare part

9 DEMOLITION

9.1 DEMOLITION

In the act of demolition it is necessary to separate the parts in plastic material from electric components. Depending upon the Norms in the country you live in, you might have to separate it.

Concerning the machine's metallic mass, it is enough to subdivide the steel parts and those of other metals or alloys, for a proper recycling by smelting.

10. ATTACHMENTS

10.1 DECLARATIONS

You can find attached here the following declarations

- Declaration of conformity to the Norm 89/392/CEE

10.2 SCHEMES

You can find attached here the following schemes:

- (A) Mechanic Schemes
- (B) Pneumatic Scheme
- (C) Plates location
- (D) Sharpening Table

MITRE-MITE VN 4L

DWG Nr. 004.3.125

3P - Stroke "125"

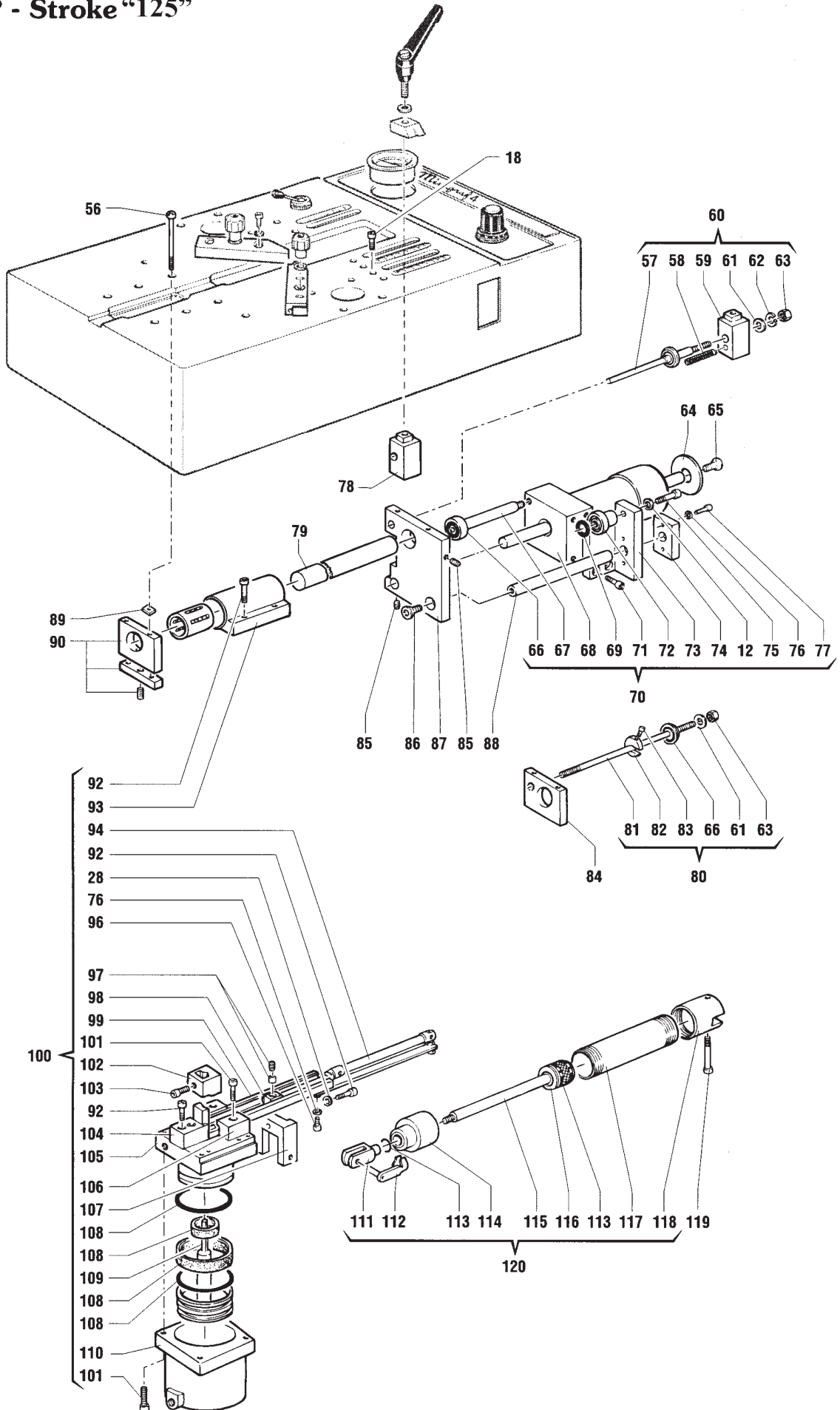

MITRE-MITE VN 4 L

DWG Nr. 004.3.125

Optional

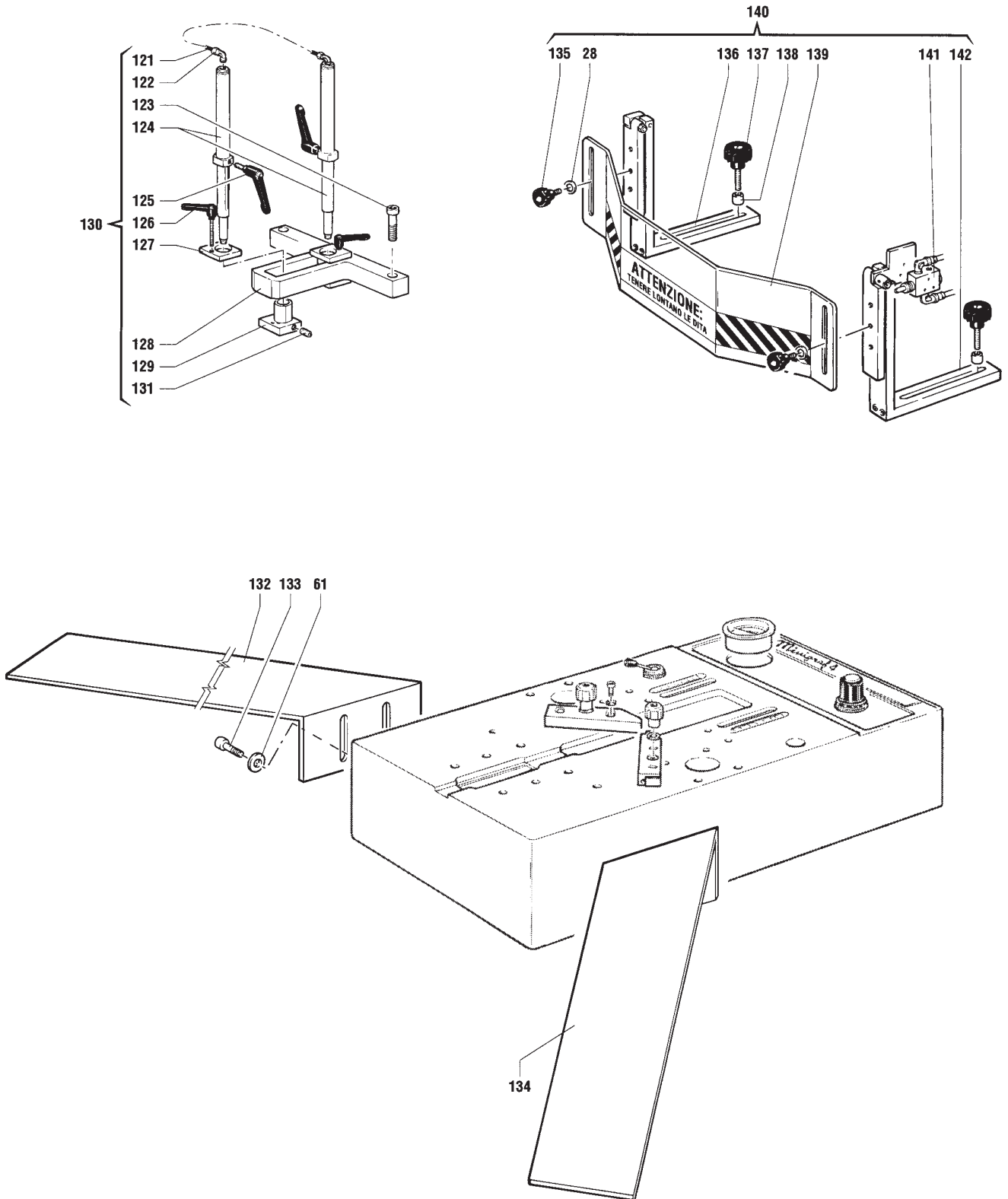

Mitre Mite VN4L Stroke 125(5")

Dwg Nr. 004.3.125

Ref.	Code Number	Qty	Description
1	244660010	1	Ratchet Handle For Top Slide 12mm x 1.25
2	336100030	1	Washer OD=30 ID=12
3	714300041	1	Set Screw 12 x 60 1.25 Pitch
4	710100151	2	Screw SCS 10 x 25
5	243170010	1	Ratchet Handle For Hold Down
6	383600061	1	5" Hold Down Rod Clamp 14mm
7	376400010	1	Support
8	334000181	1	Hold Down Rod D=20 L=160
9	244120130	1	Base For Magnetic Hold Down Rod
9	244120120	1	Magnetic Rod Complete
9a	242230020	1	Square Pressure Plate With Felt For Magnetic Base
9b	242230010	1	Round Pressure Plate With felt For Magnetic base
9c	242230140	1	Square Pressure Plate With Rubber For Magnetic Base
9d	242230040	1	Round Pressure Plate With Rubber For Magnetic base
9e	242230060	1	Square Pressure Plate With Rubber Bolt On Part
9f	242230070	1	Double Square Rubber Pressure Plate
9g	242230080	1	Triple Square Rubber Pressure Plate
10	710100042	1	Screw SCS 5 x 10
11	243170020	3	Ratchet Handle For Stop M8 x 35
12	336100070	3	Washer OD =16 ID=8 H=4
13	397150010	3	Clamp Right "Z"
14	734230004	1	Pressure Gauge OD=50, 0-12 Bar
15	735630002	1	Pressure Regulator 1/8" 0-8 Bar
16	373400040	1	Extension Lever
17	710200041	1	Screw FCS 5X10
18	710100074	8	Screw SCS 6 X 14
19	732290002	2	Foot Pedal, Touch Lever, Pushbutton Control Valve
20	292350010	1	Touch Lever VN4L With Valve
21	366710170	1	Inch rule "Y" axis
22	366710160	1	Inch rule "Z" axis
23	336300030	2	Tilt Fence Knob, 3 Knob Style
24	337500030	3	Spacer OD=24 ID=12 H=7
25	243160030	1	Dial Adjust Fence
26	211250210	1	Main frame
27	710100076	4	Screw SCS 6 x 18
28	718100003	14	Washer 6mm
29	392750010	1	Support
30	242170110	1	Spring Front Clamp, 4L, E3L, MC
31	366210030	1	Special Screw 6 x 8mm
32	753320001	1	Front Clamp Knob
33	710100075	4	Screw SCS 6 x 16
34	732140001	1	Pneumatic Loading Valve (PLV)
35	366710250	1	Inch rule "X" axis
36	381300210	1	Stop Block "Y"
37	352400020	2	Vertical Cylinder Head
38	298390070	2	Gasket Kit Vertical Cylinder
39	331000020	2	Piston For Vertical Cylinder
40	225220060	2	Complete Vertical Cylinder
41	333500030	2	Vertical Cylinder Sleeve ID=55
42	352200040	2	Vertical Cylinder Bottom OD=55
43	710100088	8	Screw SCS 6 x 110mm
44	371200010	2	Slide
45	384400010	1	Support
46	710600002	4	Set Screw 6 x 10

Mitre Mite VN4L Stroke 125(5")

Dwg Nr. 004.3.125

Ref.	Code Number	Qty	Description
47	710200081	2	Screw FCS 8 x 16
48	352200030	1	Front Clamp Cylinder Head OD=45
49	352200020	1	Front Clamp Cylinder Head OD=45
50	225120010	1	Complete Front Clamp Cylinder
51	331000030	1	Piston
52	298390050	1	Gasket Kit Front Clamp Cylinder
53	333500020	1	Front Clamp Cylinder Sleeve
54	710100087	4	Screw SCS 6 x 75
55	384200020	2	Bracket For Front Clamp
56	710100084	4	Screw SCS 6 x 55
57	366910010	1	Stud Bolt M8 x 140
57	336600020	1	Bushing M8
57	336500040	1	Bushing M8
58	765000005	1	Spring (Limit Switch)
59	383900110	1	X Stop Block
60	248000110	1	Complete Stop Assembly "X" Position
61	718100004	6	Special Washer ID= 8.5mm
62	718300004	1	Lock Washer ID=8.5mm
63	715650004	2	Nut M8
64	336100190	1	Rubber Washer
65	710200082	1	Screw FCS 8 x 14
66	336600020	2	Bushing M8
67	334000190	1	Rod OD=12 L=90
68	352200130	1	Movement Cylinder Head OD =55
69	720250009	5	Rubber Spacer 13 X 20 X 3.5
70	223130050	1	Cylinder Complete 3rd Position
71	710100072	4	Screw SCS 6 x 10
72	336600050	1	Bushing M8
73	381300100	1	Support
74	381600060	1	Block Slide
75	710100115	1	Screw SCS 8 x 25
76	718100002	4	Washer
77	710100047	2	Screw SCS 5 x 20
78	383900100	1	Stop Block "Z"
79	336600050	1	Bushing
80	248000040	1	Complete Stop Assembly "Z" Position
81	366910020	1	Stud Bolt M8 x 180
82	337500050	1	Spacer OD=29 ID=8.5 H=10
83	710100049	1	Screw SCS 5 x 14
84	383900080	1	Support
85	714300017	2	Set Screw 6 x 10
86	710200084	1	Screw FSC 8 x 25
87	383900030	1	Support
88	334000270	1	Guide Rod OD=12 L=170
89	381600100	8	Leveller Spacer
90	372900030	2	Support
90	383900070	2	Support
90	714300016	2	Set Screw 6mm x 8mm
92	710100079	8	Screw SCS 6 x 25
93	247000020	1	Complete Bushing
94	221330020	1	Complete Nail Feed Cylinder
96	710100042	2	Screw SCS 5 x 10
97	244500010	1	Set Screw + Pin (Clawpusher)
98	395450021	1	Claw Pusher Post 2000

Mitre Mite VN4L Stroke 125(5")

Dwg Nr. 004.3.125

Ref.	Code Number	Qty	Description
99	398350031	1	Steel Nail Magazine 2000+
100	224240060	1	Complete Driver Assembly
101	710100093	6	Screw
102	394950060	1	Nail Head H5
102	394950020	1	Nail Head H7
102	394950030	1	Nail Head H10
102	394950040	1	Nail Head H12
102	394950050	1	Nail head H15
103	710100070	5	Screw SCS 6 x 8
104	384200050	1	L-Support Block
105	352200110	1	Head Driver Cylinder
106	383600020	2	Block For Magazine
107	381300090	1	Support
108	298390040	1	Driver Cylinder Gasket Kit
109	298420030	1	Piston & Driver Blade
110	352200050	1	Driver Cylinder
111	753770001	1	Head
112	753820001	1	Clips M8 x 25
113	298390030	1	Gasket Kit Movement Cylinder OD=32 ID=22
114	352400060	1	Head Movement Cylinder OD=40
115	331500140	1	Rod
116	331000200	1	Movement Cylinder Piston OD=32
117	333500190	1	Movement Cylinder Sleeve OD=32
118	352400070	1	Movement Cylinder Base OD=40
119	710100118	1	Screw SCS 8 x 40
120	223130060	1	Complete Movement Cylinder 5"
121	365110010	1	Hose OD=4
122	730800001	2	Pressure Fitting 90 Degree (Double Hydraulic)
123	710100157	2	Screw SCS 10 x30
124	223130071	1	Hydraulic Cylinder Set
125	243170010	2	Ratchet Handle For Hold Down
126	753170005	2	Ratchet Handle For Double Hydraulic 6 X 50MM
127	383900190	2	Plate, Top Double Hydraulic
128	376400060	1	Support
129	383900200	2	Slide
130	242230030	1	Complete Double Hydraulic Hold Down
131	714300042	2	Set Screw 12 X 16 P=1.25
132	391650511	1	Left Extension Arm
133	710100112	4	Screw SCS 8 x 14
134	753320005	1	Right Extension Arm
134	291650010	1	Extension Arm Set
135	753320005	2	Knob D=20 M6X25
136	241300010	1	Support
137	753320002	2	Knob Fence Stop Clamp
138	336100020	2	Washer For Fence Stop Clamp
139	398950020	1	Shield, Protective
140	248950010	1	Safety Guard Complete
141	732540003	1	Valve For Safety guard
142	241300020	1	Support

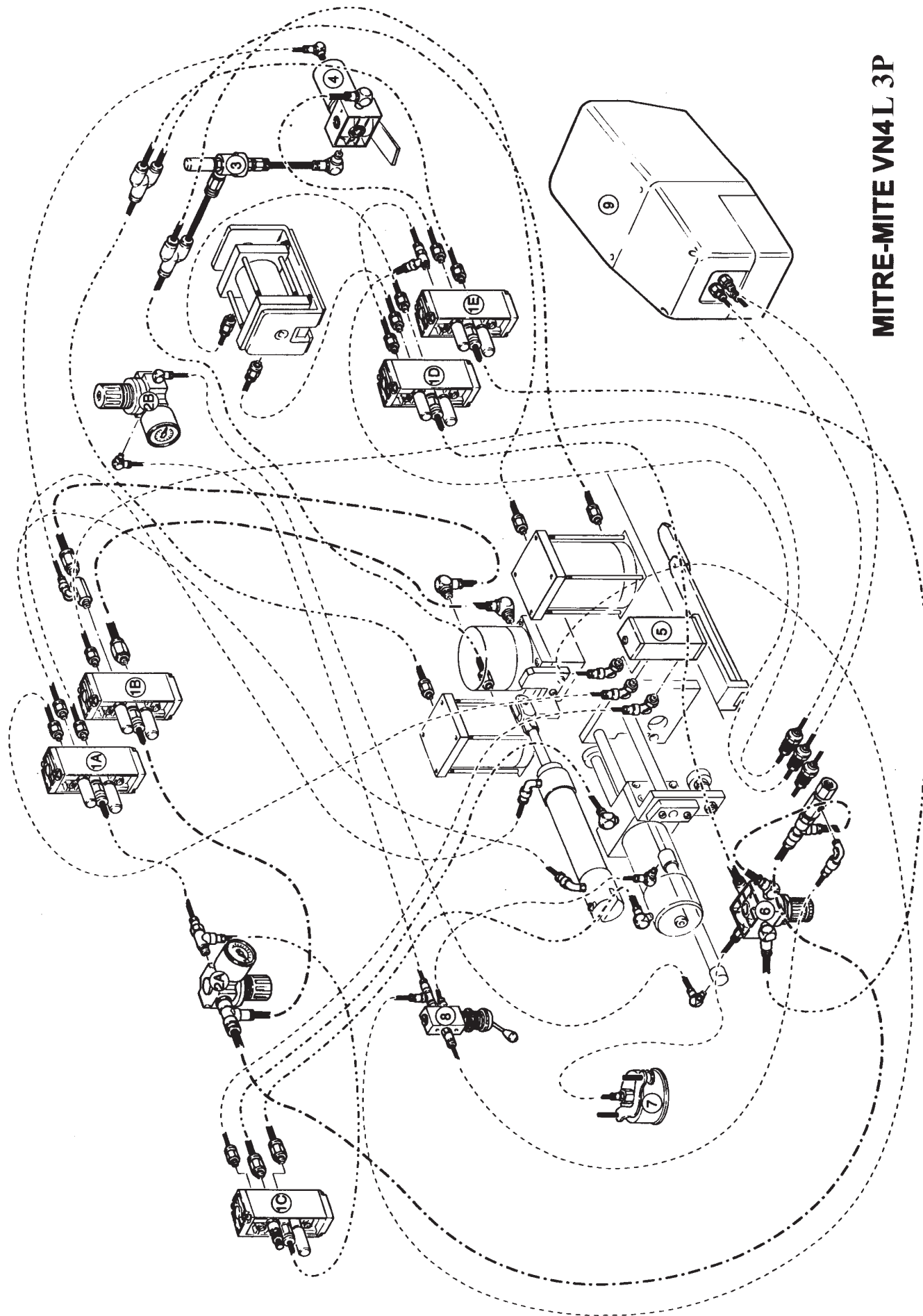

MITRE-MITE VN4L 3P

Mitre Mite VN4L Stroke 125(5'')

Pneumatic Parts

Dwg Nr.004.3.125

Ref.	Code Number	Qty	Description
1A	732440003	1	Control Valve
1B	732440003	1	Control Valve
1C	732440003	1	Control Valve
1D	732440003	1	Control Valve
1E	732440003	1	Control Valve
2A	735630002	1	Pressure Regulator 1/8" 0-8 Bar
2B	735630002	1	Pressure Regulator 1/8" 0-8 Bar
3	732390001	1	Exhaust Valve 1/8"
4	735130006	1	Soft Clamp regulator
5	732290002	1	Foot Pedal, Touch Lever, Pushbutton Control Valve
6	735630002	1	Pressure Regulator 1/8" 0-8 Bar
7	734230003	1	Main Pressure Gauge
8	732140001	1	Pneumatic Loading Valve (PLV)
9	735940001	1	Silencer Adjustable 1/8"
9	756700003	10	1/8" Silencer

SCHEMES C - Plates location

CAUTION!
FOR YOUR SECURITY
DISCONNECT THE AIR
SUPPLY BEFORE REPLACING
THE V-NAIL CLAW HEAD OR
ANY MAINTENANCE OPERATION

CAUTION: KEEP THE FINGERS AWAY

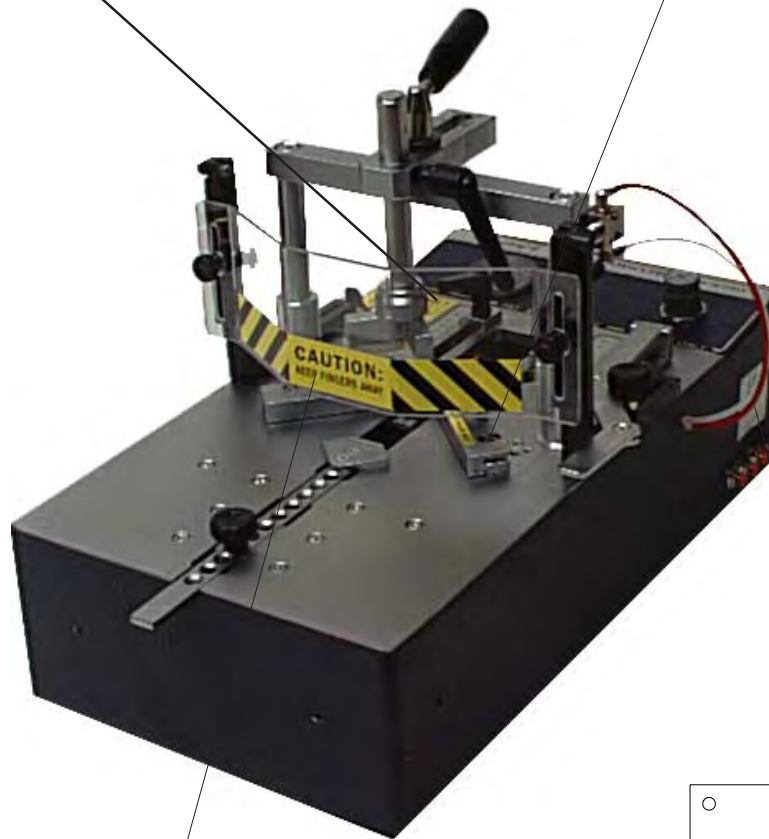

SCHEME D - SHARPENING TABLE

	SOFT WOOD			HARD WOOD		
	A	B	C	D	E	F
<i>Height mm</i>	Very soft wood	Soft wood	Averaged soft wood	Averaged hard wood	Hard wood	Very hard wood
H 3* mm	HPT	HPT	HPT	HPT	HPT	HPT
H 5* mm	HPT	HPT	HPT	HPT	HPT	HPT
H 7 mm	SPT	SPT	HPT	HPT	HPT	HPT
H 10 mm	SPT	SPT	HPT	HPT	HPT	HPT
H 12 mm	SPT	SPT	HPT	HPT	HPT	HPT
H 15 mm	SPT	SPT	HPT	HPT	HPT	HPT

SPT Suitable for soft wood such as: Thailand and Asian South-East wood, Cedar, Pine, Bass, Banak, Obeche, Poplar
Other materials: Cellular, Polystyrene, Vertical Grain MDF

HPT Suitable for soft wood such as: Thailand and Asian South-East wood, Cedar, Pine, Bass, Banak, Obeche, Poplar , polystyrene, pvc

HPT Suitable for soft wood such as: Oak, Ash, Hickory, Pecan, Maple, Cherry, Ramin
Other materials: Horizontal grain MDF

HDF Suitable for horizontal Grain MDF & HDF



In order to stack 2 or more V-nails per junction, use V-nails coded **HPT OR HDF**